

# 低電流、高性能NPNシリコン・バイポーラ・トランジスタ

## AT-32032

### 特長

低電流、低電圧用高性能トランジスタ  
900MHz,5mA,2.7Vで特性を保証  
NF: 1.3dB(最大)、1.0dB(標準)  
Ga: 13.5dB(最小)、15dB(標準)  
P<sub>1dB</sub>: +13dBm(標準)@20mA,2.7V  
SOT-323 (SC-70 3ピン相当) 表面実装プラスチック・パッケージ  
テープ・リール・オプションを用意

### 応用

PDC、PHS、CDMAなどの移動体通信端末およびワイヤレスLANなどのデータ通信機器

### 3-Lead SC-70 (SOT-323) Surface Mount Plastic Package

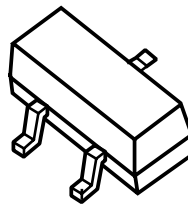

### Pin Configuration

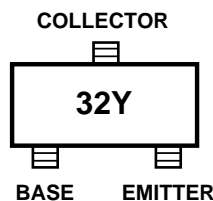

注：“Y”はデットコードを表わします。

### 概要

AT-32032は低電圧動作用に最適化された高性能NPNバイポーラ・トランジスタです。パッケージはSOT-323 (SC-70 3ピン相当)の表面実装プラスチック・パッケージです。

2.7Vで特性を最適化しているため、900MHz,1.9GHz,2.4GHzでのLNA、ゲイン・ステージ、バッファ、発振器、またはアクティブ・ミキサなどのようなバッテリー動作に最適で、セルラやPCSのハンドセットやISMバンドのシステムに使用可能です。900MHzでは、2.7V, 5mAのバイアスで1.0dB(標準)NF、15dB(標準)のゲインが得られます。また、比較的人力整合に影響を受けずに、良好な雑音特性が得られます。1V,1mAでも高ゲインなので、900MHzのページャにも使用することができます。中程度の出力パワー(+13dBm P<sub>1dB</sub>)と低雑音により、低電流で広いダイナミック・レンジに対応するデバイスです。

## AT-32032 Absolute Maximum Ratings

Symbol	Parameter	Units	Absolute Maximum <sup>[1]</sup>
V <sub>EBO</sub>	Emitter-Base Voltage	V	1.5
V <sub>CBO</sub>	Collector-Base Voltage	V	11
V <sub>CEO</sub>	Collector-Emitter Voltage	V	5.5
I <sub>C</sub>	Collector Current	mA	32
P <sub>T</sub>	Power Dissipation <sup>[2, 3]</sup>	mW	200
T <sub>j</sub>	Junction Temperature	°C	150
T <sub>STG</sub>	Storage Temperature	°C	-65 to 150

**Thermal Resistance<sup>[2]</sup>:**  
 $\theta_{jc}=350^{\circ}\text{C}/\text{W}$

注1: これらのパラメータのいずれかを超える状態でデバイスを動作させると、永久的な損傷を受ける可能性があります。

注2: T<sub>MOUNTING SURFACE</sub>=25°。

注3: T<sub>C</sub>>80 の場合は、2.86mW/ の割合で定格を下げてください。

## Electrical Specifications, T<sub>A</sub>=25°C

Symbol	Parameters and Test Conditions	Units	Min.	Typ.	Max.
NF	Noise Figure V <sub>CE</sub> =2.7V, I <sub>C</sub> =5mA	f=0.9 GHz f=1.8 GHz		1.0 1.25	1.3
G <sub>A</sub>	Associated Gain V <sub>CE</sub> =2.7V, I <sub>C</sub> =5mA	f=0.9 GHz f=1.8 GHz	13.5	15 10.5	
h <sub>FE</sub>	Forward Current Transfer Ratio V <sub>CE</sub> =2.7V, I <sub>C</sub> =5mA		70		300
I <sub>CBO</sub>	Collector Cutoff Current V <sub>CB</sub> =3V				0.2
I <sub>EBO</sub>	Emitter Cutoff Current V <sub>EB</sub> =1V				1.5

## AT-32032 Characterization Information, T<sub>A</sub>=25°C

Symbol	Parameters and Test Conditions	Units	Typ.
P <sub>1dB</sub>	Power at 1 dB Gain Compression (opt tuning) V <sub>CE</sub> =2.7V, I <sub>C</sub> =20mA	f=0.9 GHz	13
G <sub>1dB</sub>	Gain at 1 dB Gain Compression (opt tuning) V <sub>CE</sub> =2.7V, I <sub>C</sub> =20mA	f=0.9GHz	15.5
IP <sub>3</sub>	Output Third Order Intercept Point (opt turning) V <sub>CE</sub> =2.7V, I <sub>C</sub> =20mA	f=0.9 GHz	23
S <sub>21</sub>   <sub>E</sub> <sup>2</sup>	Gain in 50 Ω System V <sub>CE</sub> =2.7V, I <sub>C</sub> =2mA	f=0.9 GHz	11.5

## AT-32032 Typical Performance

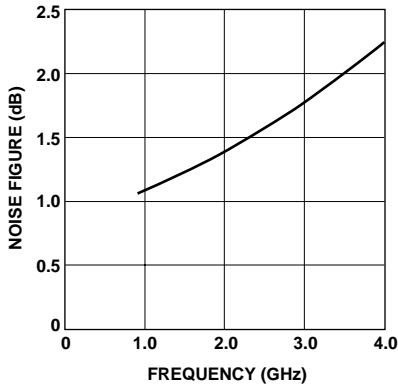

Figure 1. AT-32032 Typical Noise Figure vs. Frequency at 1V, 1 mA.

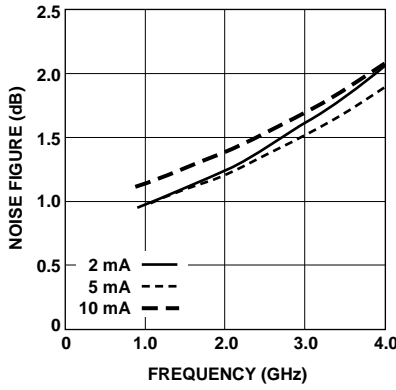

Figure 2. AT-32032 Typical Noise Figure vs. Frequency and Current at 2.7V.

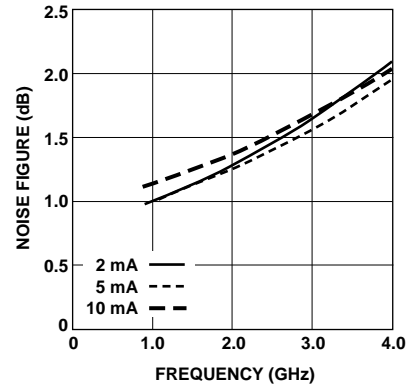

Figure 3. AT-32032 Typical Noise Figure vs. Frequency and Current at 5V.

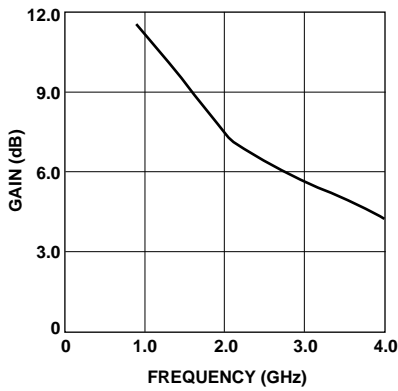

Figure 4. AT-32032 Associated Gain vs. Frequency at 1V, 1 mA.

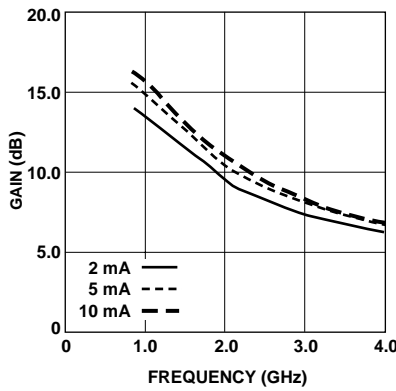

Figure 5. AT-32032 Associated Gain vs. Frequency and Current at 2.7V.

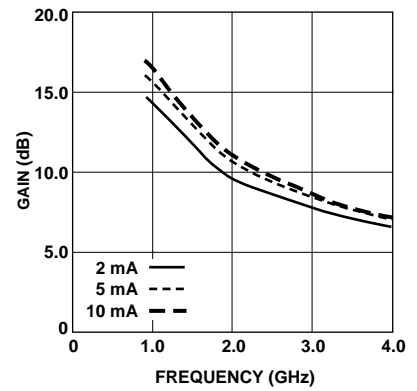

Figure 6. AT-32032 Associated Gain vs. Frequency and Current at 5V.

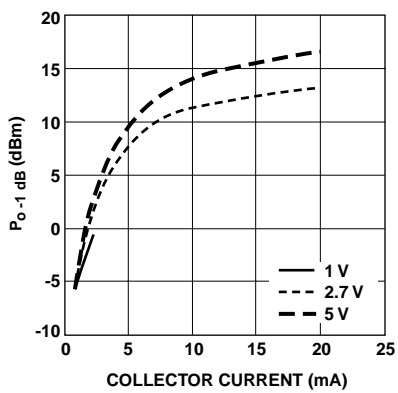

Figure 7. AT-32032  $P_{1\text{ dB}}$  vs. Collector Current and Voltage (valid up to 2.4GHz).

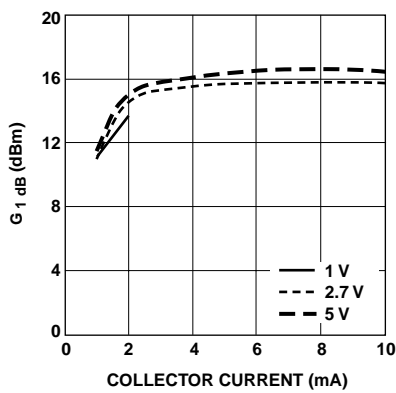

Figure 8a.  $G_{1\text{ dB}}$  vs. Collector Current and Voltage (at 900MHz).

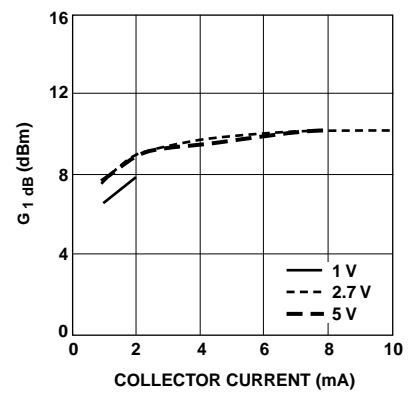

Figure 8b.  $G_{1\text{ dB}}$  vs. Collector Current and Voltage (at 1.8 GHz).

**AT-32032 Typical Scattering Parameters, Common Emitter,  $Z_O = 50 \Omega$ ,  $V_{CE} = 1 \text{ V}$ ,  $I_C = 1 \text{ mA}$**

Freq. GHz	$S_{11}$		$S_{21}$			$S_{12}$			$S_{22}$	
	Mag	Ang	dB	Mag	Ang	dB	Mag	Ang	Mag	Ang
0.5	0.852	-51	9.61	3.024	137	-20.65	0.093	59	0.895	-21
0.75	0.760	-74	8.68	2.717	119	-18.39	0.120	48	0.821	-29
1.0	0.655	-94	7.68	2.420	104	-17.35	0.136	40	0.756	-35
1.5	0.523	-130	5.75	1.939	79	-16.68	0.147	32	0.665	-44
2.0	0.451	-161	4.11	1.606	60	-16.52	0.149	31	0.615	-52
3.0	0.403	147	1.76	1.224	30	-14.42	0.190	43	0.565	-71
4.0	0.419	104	0.20	1.023	7	-10.21	0.309	42	0.527	-96
5.0	0.459	69	-0.92	0.899	-11	-6.58	0.469	26	0.478	-127
6.0	0.497	45	-1.56	0.836	-26	-4.22	0.615	5	0.411	-168
7.0	0.529	27	-1.84	0.809	-41	-2.85	0.720	-18	0.379	141
8.0	0.561	13	-2.07	0.788	-56	-2.33	0.765	-40	0.425	96
9.0	0.590	-2	-2.34	0.764	-72	-2.28	0.769	-60	0.495	63
10.0	0.626	-17	-2.74	0.729	-87	-2.57	0.744	-79	0.555	38

**AT-32032 Typical Noise Parameters, Common Emitter,  $Z_O = 50 \Omega$ ,  $V_{CE} = 1 \text{ V}$ ,  $I_C = 1 \text{ mA}$**

Freq. GHz	$F_{min}$ dB	$\Gamma_{opt}$		$R_n$ ohms	$G_{assoc}$ dB
		Mag	Ang		
0.9	1.1	0.48	63	14.5	11.5
1.8	1.3	0.51	129	6.8	8.3
2.0	1.4	0.52	143	5.2	7.4
2.5	1.6	0.54	177	2.9	6.4
3.0	1.8	0.57	-153	4.9	5.7
3.5	2.0	0.61	-125	12.7	5.0
4.0	2.2	0.65	-102	26.0	4.2

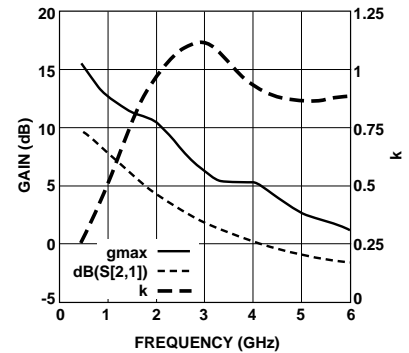

**Figure 9. Gain vs. Frequency at 1 V, 1 mA.**

Note:  $\text{dB}(|S_{21}|) = 20 * \log(|S_{21}|)$

$g_{max}$  = maximum available gain (MAG) if  $k > 1$

$g_{max}$  = maximum stable gain (MSG) if  $k < 1$

$k$  = stability factor

$$\text{MAG} = \frac{|S_{21}|}{|S_{12}|} (k \pm \sqrt{k^2 - 1})$$

$$\text{MSG} = |S_{21}| / |S_{12}|$$

$$k = \frac{1 - |S_{11}|^2 - |S_{22}|^2 + |D|^2}{2 * |S_{12}| |S_{21}|} ; D = S_{11} S_{22} - S_{12} S_{21}$$

**AT-32032 Typical Scattering Parameters, Common Emitter,  $Z_O = 50 \Omega$ ,  $V_{CE} = 2.7 \text{ V}$ ,  $I_C = 2 \text{ mA}$**

Freq. GHz	$S_{11}$		$S_{21}$			$S_{12}$			$S_{22}$	
	Mag	Ang	dB	Mag	Ang	dB	Mag	Ang	Mag	Ang
0.5	0.744	-57	14.37	5.232	130	-23.72	0.065	60	0.839	-22
0.75	0.609	-78	12.86	4.394	112	-21.73	0.082	52	0.755	-28
1.0	0.489	-96	11.40	3.714	98	-20.58	0.094	49	0.694	-31
1.5	0.351	-129	8.86	2.774	77	-19.05	0.112	48	0.625	-37
2.0	0.280	-158	6.93	2.221	61	-17.56	0.133	49	0.592	-43
3.0	0.236	149	4.28	1.636	34	-14.08	0.198	50	0.561	-59
4.0	0.258	105	2.58	1.346	11	-10.62	0.295	44	0.541	-78
5.0	0.317	72	1.36	1.170	-8	-7.54	0.420	30	0.510	-103
6.0	0.387	51	0.43	1.051	-26	-5.11	0.555	13	0.447	-135
7.0	0.455	34	-0.24	0.973	-42	-3.28	0.686	-8	0.373	-178
8.0	0.516	19	-0.80	0.913	-58	-2.24	0.772	-30	0.367	129
9.0	0.563	3	-1.39	0.852	-74	-1.86	0.807	-52	0.431	86
10.0	0.610	-14	-2.00	0.794	-89	-2.00	0.795	-73	0.504	55

**AT-32032 Typical Noise Parameters,**

Common Emitter,  $Z_O = 50 \Omega$ ,  $V_{CE} = 2.7 \text{ V}$ ,  $I_C = 2 \text{ mA}$

Freq. GHz	$F_{min}$ dB	$\Gamma_{opt}$		$R_n$ ohms	$G_{assoc}$ dB
		Mag	Ang		
0.9	0.9	0.38	57	10.6	14.0
1.8	1.2	0.41	124	6.2	10.5
2.0	1.2	0.42	136	5.3	9.4
2.5	1.4	0.44	176	3.4	8.4
3.0	1.6	0.47	-152	4.9	7.5
3.5	1.8	0.52	-123	10.5	6.9
4.0	2.1	0.57	-100	20.6	6.2

$g_{max}$  = maximum available gain (MAG) if  $k > 1$

$g_{max}$  = maximum stable gain (MSG) if  $k < 1$

$k$  = stability factor

$$MAG = \left| \frac{S_{21}}{S_{12}} \right| (k \pm \sqrt{k^2 - 1})$$

$$MSG = |S_{21}| / |S_{12}|$$

$$k = \frac{1 - |S_{11}|^2 - |S_{22}|^2 + |D|^2}{2 * |S_{12}| |S_{21}|} ; D = S_{11}S_{22} - S_{12}S_{21}$$

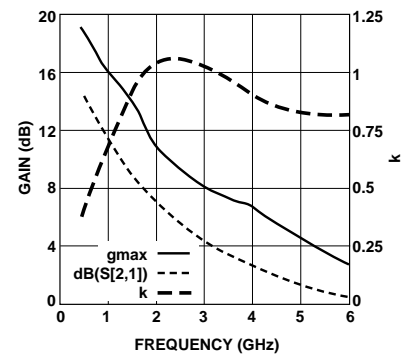

Figure 10. Gain vs. Frequency at 2.7 V, 2 mA.

Note:  $\text{dB}(|S_{21}|) = 20 * \log(|S_{21}|)$

**AT-32032 Typical Scattering Parameters, Common Emitter,  $Z_O = 50 \Omega$ ,  $V_{CE} = 2.7 \text{ V}$ ,  $I_C = 5 \text{ mA}$**

Freq. GHz	$S_{11}$		$S_{21}$			$S_{12}$		$S_{22}$		
	Mag	Ang	dB	Mag	Ang	dB	Mag	Ang	Mag	Ang
0.5	0.484	-70	18.65	8.559	113	-25.51	0.053	62	0.680	-26
0.75	0.344	-88	16.04	6.339	98	-23.25	0.069	61	0.602	-28
1.0	0.257	-103	13.98	5.000	87	-21.46	0.085	61	0.561	-29
1.5	0.165	-130	10.90	3.509	70	-18.59	0.118	60	0.522	-33
2.0	0.124	-160	8.76	2.740	57	-16.29	0.153	57	0.502	-39
3.0	0.112	143	5.93	1.979	33	-12.69	0.232	48	0.477	-55
4.0	0.144	100	4.19	1.620	13	-9.89	0.320	37	0.454	-73
5.0	0.209	72	3.01	1.414	-7	-7.55	0.419	24	0.418	-95
6.0	0.296	57	2.14	1.279	-25	-5.58	0.526	8	0.353	-124
7.0	0.394	43	1.43	1.179	-43	-3.94	0.636	-10	0.275	-166
8.0	0.489	28	0.70	1.084	-61	-2.79	0.725	-30	0.270	137
9.0	0.564	10	-0.12	0.986	-78	-2.18	0.778	-50	0.355	91
10.0	0.627	-9	-1.05	0.886	-94	-2.10	0.786	-71	0.455	58

**AT-32032 Typical Noise Parameters, Common Emitter,  $Z_O = 50 \Omega$ ,  $V_{CE} = 2.7 \text{ V}$ ,  $I_C = 5 \text{ mA}$**

Freq. GHz	$F_{min}$ dB	$\Gamma_{opt}$		$R_n$ ohms	$G_{assoc}$ dB
		Mag	Ang		
0.9	0.9	0.23	71	7.5	15.6
1.8	1.2	0.295	138	5.1	11.5
2.0	1.2	0.31	152	4.6	10.4
2.5	1.3	0.35	-173	4.1	9.1
3.0	1.5	0.41	-142	5.8	8.2
3.5	1.7	0.47	-114	11.0	7.4
4.0	1.9	0.54	-93	20.0	6.7

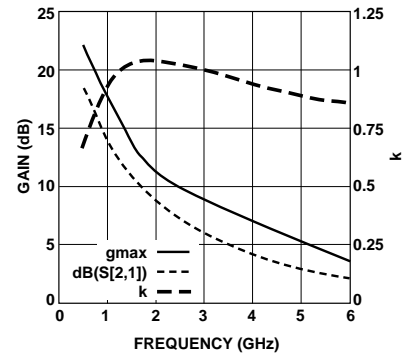

**Figure 11. Gain vs. Frequency at 2.7 V, 5 mA.**

Note:  $\text{dB}(|S_{21}|) = 20 * \log(|S_{21}|)$

$g_{max}$  = maximum available gain (MAG) if  $k > 1$   
 $g_{max}$  = maximum stable gain (MSG) if  $k < 1$   
 $k$  = stability factor

$$\text{MAG} = \left| \frac{S_{21}}{S_{12}} \right| (k \pm \sqrt{k^2 - 1})$$

$$\text{MSG} = |S_{21}| / |S_{12}|$$

$$k = \frac{1 - |S_{11}|^2 - |S_{22}|^2 + |D|^2}{2 * |S_{12}| |S_{21}|} ; D = S_{11} S_{22} - S_{12} S_{21}$$

**AT-32032 Typical Scattering Parameters, Common Emitter,  $Z_O = 50 \Omega$ ,  $V_{CE} = 2.7 \text{ V}$ ,  $I_C = 10 \text{ mA}$**

Freq. GHz	$S_{11}$		$S_{21}$			$S_{12}$			$S_{22}$	
	Mag	Ang	dB	Mag	Ang	dB	Mag	Ang	Mag	Ang
0.5	0.292	-76.768	20.197	10.230	102.252	-26.558	0.047	68.475	0.577	-23.850
0.75	0.194	-89.611	17.121	7.179	90.014	-23.688	0.065	68.467	0.528	-24.315
1.0	0.139	-100.612	14.850	5.527	81.084	-21.463	0.085	67.769	0.504	-25.449
1.5	0.081	-126.165	11.624	3.813	66.997	-18.160	0.124	64.256	0.481	-30.013
2.0	0.057	-160.808	9.409	2.954	54.862	-15.735	0.163	59.458	0.467	-36.600
3.0	0.064	131.034	6.523	2.119	33.080	-12.174	0.246	48.003	0.443	-52.023
4.0	0.103	91.686	4.750	1.728	13.099	-9.551	0.333	35.089	0.418	-70.196
5.0	0.169	69.993	3.580	1.510	-5.823	-7.424	0.425	21.009	0.378	-92.177
6.0	0.258	58.339	2.719	1.368	-24.160	-5.668	0.521	5.600	0.309	-119.643
7.0	0.362	46.145	2.042	1.265	-42.430	-4.173	0.619	-11.469	0.224	-160.597
8.0	0.466	31.083	1.334	1.166	-60.668	-3.083	0.701	-30.211	0.217	138.234
9.0	0.553	13.235	0.533	1.063	-78.273	-2.402	0.758	-50.020	0.307	91.480
10.0	0.628	-5.840	-0.404	0.955	-95.268	-2.236	0.773	-69.960	0.419	58.813

**AT-32032 Typical Noise Parameters,**

Common Emitter,  $Z_O = 50 \Omega$ ,  $V_{CE} = 2.7 \text{ V}$ ,  $I_C = 10 \text{ mA}$

Freq. GHz	$F_{min}$ dB	$\Gamma_{opt}$		$R_n$ ohms	$G_{assoc}$ dB
		Mag	Ang		
0.9	1.1	0.15	87	7.6	16.2
1.8	1.3	0.23	159	5.6	11.9
2.0	1.4	0.26	173	5.3	11.0
2.5	1.5	0.32	-156	5.7	9.5
3.0	1.7	0.38	-128	8.6	8.4
3.5	1.9	0.45	-105	14.8	7.6
4.0	2.0	0.52	-84	25.0	6.8

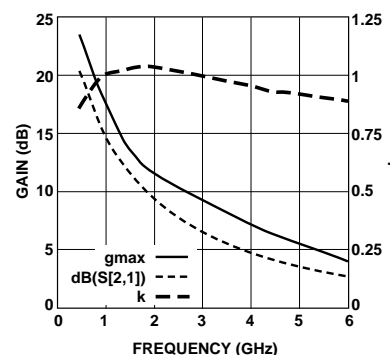

Figure 12. Gain vs. Frequency at 2.7 V, 10 mA.

Note:  $\text{dB}(|S_{21}|) = 20 * \log(|S_{21}|)$

$g_{max}$  = maximum available gain (MAG) if  $k > 1$

$g_{max}$  = maximum stable gain (MSG) if  $k < 1$

$k$  = stability factor

$$\text{MAG} = \left| \frac{S_{21}}{S_{12}} \right| (k \pm \sqrt{k^2 - 1})$$

$$\text{MSG} = |S_{21}| / |S_{12}|$$

$$k = \frac{1 - |S_{11}|^2 - |S_{22}|^2 + |D|^2}{2 * |S_{12}| |S_{21}|} ; D = S_{11}S_{22} - S_{12}S_{21}$$

**AT-32032 Typical Scattering Parameters, Common Emitter,  $Z_O = 50 \Omega$ ,  $V_{CE} = 5 \text{ V}$ ,  $I_C = 2 \text{ mA}$**

Freq. GHz	$S_{11}$		$S_{21}$			$S_{12}$			$S_{22}$	
	Mag	Ang	dB	Mag	Ang	dB	Mag	Ang	Mag	Ang
0.1	0.940	-13	17.5	7.500	167	-36.0	0.016	83	0.981	-5
0.5	0.732	-56	14.9	5.588	129	-23.8	0.064	60	0.842	-22
0.9	0.518	-87	12.4	4.165	104	-21.1	0.088	51	0.714	-29
1.0	0.484	-93	11.6	3.814	99	-20.6	0.093	50	0.699	-30
1.5	0.342	-124	9.0	2.824	78	-19.0	0.112	49	0.632	-36
1.8	0.291	-142	7.8	2.466	67	-18.1	0.125	49	0.606	-40
2.0	0.265	-153	7.1	2.267	61	-17.5	0.134	50	0.596	-43
3.0	0.212	151	4.5	1.670	34	-14.0	0.199	50	0.566	-58
4.0	0.238	103	2.7	1.367	11	-10.7	0.293	43	0.549	-77
5.0	0.306	70	1.5	1.186	-8	-7.6	0.416	30	0.515	-102
6.0	0.383	50	0.6	1.067	-26	-5.2	0.550	13	0.453	-134
7.0	0.456	34	-0.1	0.990	-43	-3.3	0.682	-8	0.375	-177
8.0	0.523	19	-0.7	0.918	-59	-2.3	0.771	-31	0.373	130
9.0	0.573	2	-1.3	0.857	-75	-1.9	0.805	-53	0.437	86
10.0	0.620	-14	-2.0	0.792	-90	-2.0	0.791	-73	0.515	54

**AT-32032 Typical Noise Parameters,**

Common Emitter,  $Z_O = 50 \Omega$ ,  $5 \text{ V}$ ,  $I_C = 2 \text{ mA}$

Freq. GHz	$F_{\min}$ dB	$\Gamma_{\text{opt}}$		$R_n$ ohms	$G_{\text{assoc}}$ dB
		Mag	Ang		
0.9	1.0	0.48	50	14.7	14.8
1.8	1.2	0.445	118	7.4	10.1
2.0	1.3	0.44	134	5.8	9.5
2.5	1.5	0.43	172	3.7	8.5
3.0	1.7	0.47	-154	5.0	7.7
3.5	1.9	0.53	-123	11.3	7.0
4.0	2.1	0.58	-98	23.7	6.4

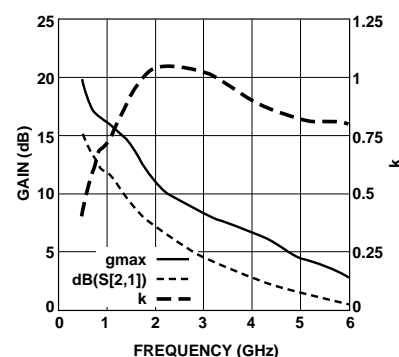

Figure 13. Gain vs. Frequency at 5 V, 2 mA.

Note:  $\text{dB}(|S_{21}|) = 20 * \log(|S_{21}|)$

$g_{\text{max}}$  = maximum available gain (MAG) if  $k > 1$

$g_{\text{max}}$  = maximum stable gain (MSG) if  $k < 1$

$k$  = stability factor

$$\text{MAG} = \left| \frac{S_{21}}{S_{12}} \right| (k \pm \sqrt{k^2 - 1})$$

$$\text{MSG} = |S_{21}| / |S_{12}|$$

$$k = \frac{1 - |S_{11}|^2 - |S_{22}|^2 + |D|^2}{2 * |S_{12}| |S_{21}|} ; D = S_{11}S_{22} - S_{12}S_{21}$$



**AT-32032 Typical Scattering Parameters, Common Emitter,  $Z_O = 50 \Omega$ ,  $V_{CE} = 5 \text{ V}$ ,  $I_C = 5 \text{ mA}$**

Freq. GHz	$S_{11}$		$S_{21}$			$S_{12}$			$S_{22}$	
	Mag	Ang	dB	Mag	Ang	dB	Mag	Ang	Mag	Ang
0.1	0.860	-19	23.8	15.523	160	-36.4	0.015	80	0.949	-9
0.5	0.496	-67	18.8	8.705	114	-25.4	0.054	63	0.690	-25
0.9	0.298	-90	14.9	5.569	92	-22.0	0.079	61	0.580	-28
1.0	0.269	-96	14.1	5.067	88	-21.4	0.085	61	0.570	-29
1.5	0.168	-119	11.0	3.558	71	-18.5	0.119	59	0.530	-33
1.8	0.133	-135	9.7	3.046	63	-17.1	0.140	58	0.514	-36
2.0	0.116	-146	8.9	2.782	58	-16.2	0.154	57	0.508	-39
3.0	0.086	150	6.1	2.011	34	-12.7	0.232	48	0.483	-54
4.0	0.121	98	4.3	1.640	13	-9.9	0.319	37	0.461	-72
5.0	0.194	70	3.1	1.434	-6	-7.6	0.417	23	0.422	-95
6.0	0.287	57	2.3	1.300	-25	-5.7	0.521	8	0.354	-124
7.0	0.390	43	1.6	1.198	-44	-4.0	0.631	-10	0.274	-166
8.0	0.491	28	0.8	1.101	-62	-2.8	0.722	-30	0.273	137
9.0	0.570	10	0	0.997	-79	-2.2	0.774	-51	0.361	91
10.0	0.640	-9	-1.0	0.891	-95	-2.1	0.781	-72	0.464	57

**AT-32032 Typical Noise Parameters, Common Emitter,  $Z_O = 50 \Omega$ ,  $V_{CE} = 5 \text{ V}$ ,  $I_C = 5 \text{ mA}$**

Freq. GHz	$F_{min}$ dB	$\Gamma_{opt}$		$R_n$ ohms	$G_{assoc}$ dB
		Mag	Ang		
0.9	1.0	0.38	52	11.7	16.1
1.8	1.2	0.335	124	6.3	11.2
2.0	1.3	0.33	140	5.3	10.5
2.5	1.4	0.35	179	4.3	9.2
3.0	1.6	0.40	-146	5.9	8.2
3.5	1.8	0.47	-118	11.5	7.5
4.0	2.0	0.54	-92	22.0	6.8

$g_{max}$  = maximum available gain (MAG) if  $k > 1$   
 $g_{max}$  = maximum stable gain (MSG) if  $k < 1$   
 $k$  = stability factor

$$MAG = \left| \frac{S_{21}}{S_{12}} \right| (k \pm \sqrt{k^2 - 1})$$

$$MSG = |S_{21}| / |S_{12}|$$

$$k = \frac{1 - |S_{11}|^2 - |S_{22}|^2 + |D|^2}{2 * |S_{12}| |S_{21}|}; \quad D = S_{11}S_{22} - S_{12}S_{21}$$

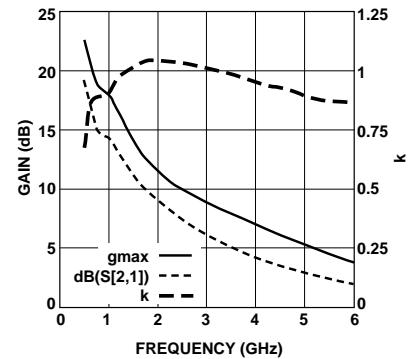

Figure 14. Gain vs. Frequency at 5 V, 5 mA.

Note:  $\text{dB}(|S_{21}|) = 20 * \log(|S_{21}|)$

**AT-32032 Typical Scattering Parameters, Common Emitter,  $Z_O = 50 \Omega$ ,  $V_{CE} = 5 \text{ V}$ ,  $I_C = 10 \text{ mA}$**

Freq. GHz	$S_{11}$		$S_{21}$			$S_{12}$			$S_{22}$	
	Mag	Ang	dB	Mag	Ang	dB	Mag	Ang	Mag	Ang
0.1	0.751	-26	27.7	24.169	152	-37.1	0.014	78	0.898	-13
0.5	0.322	-70	20.3	10.383	103	-26.4	0.048	68	0.584	-24
0.9	0.181	-84	15.9	6.208	85	-22.1	0.078	68	0.514	-25
1.0	0.160	-88	15.0	5.623	82	-21.3	0.086	67	0.508	-26
1.5	0.094	-102	11.8	3.885	68	-18.1	0.125	64	0.483	-30
1.8	0.068	-114	10.4	3.304	60	-16.5	0.149	61	0.473	-34
2.0	0.055	-123	9.6	3.012	56	-15.6	0.165	59	0.468	-37
3.0	0.032	146	6.7	2.161	34	-12.1	0.248	47	0.444	-52
4.0	0.075	86	4.9	1.759	14	-9.5	0.334	34	0.419	-70
5.0	0.148	67	3.7	1.538	-5	-7.5	0.424	20	0.375	-92
6.0	0.243	58	2.9	1.397	-24	-5.7	0.517	5	0.301	-120
7.0	0.354	47	2.2	1.292	-42	-4.3	0.613	-12	0.214	-162
8.0	0.464	32	1.5	1.190	-61	-3.2	0.695	-31	0.214	136
9.0	0.555	14	0.7	1.083	-79	-2.5	0.751	-51	0.311	89
10.0	0.636	-5	-0.3	0.967	-96	-2.3	0.765	-71	0.426	57

**AT-32032 Typical Noise Parameters, Common Emitter,  $Z_O = 50 \Omega$ ,  $V_{CE} = 5 \text{ V}$ ,  $I_C = 10 \text{ mA}$**

Freq. GHz	$F_{min}$ dB	$\Gamma_{opt}$		$R_n$ ohms	$G_{assoc}$ dB
		Mag	Ang		
0.9	1.1	0.29	69	10.0	17.0
1.8	1.3	0.25	143	6.1	11.8
2.0	1.4	0.26	159	5.6	11.0
2.5	1.5	0.31	-165	5.5	9.6
3.0	1.7	0.37	-133	8.1	8.5
3.5	1.9	0.45	-106	14.6	7.7
4.0	2.1	0.52	-84	25.7	6.9

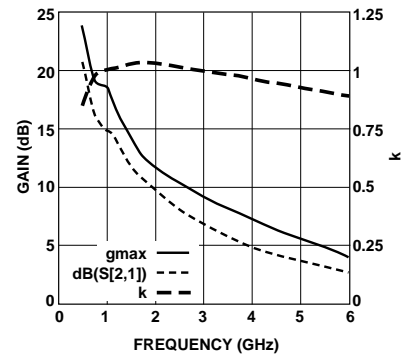

Figure 15. Gain vs. Frequency at 5 V, 10 mA.

Note:  $\text{dB}(|S_{21}|) = 20 * \log(|S_{21}|)$

$g_{max}$  = maximum available gain (MAG) if  $k > 1$

$g_{max}$  = maximum stable gain (MSG) if  $k < 1$

$k$  = stability factor

$$\text{MAG} = \frac{|S_{21}|}{|S_{12}|} (k \pm \sqrt{k^2 - 1})$$

$$\text{MSG} = |S_{21}| / |S_{12}|$$

$$k = \frac{1 - |S_{11}|^2 - |S_{22}|^2 + |D|^2}{2 * |S_{12}| |S_{21}|} ; D = S_{11} S_{22} - S_{12} S_{21}$$

### AT-32032応用

AT-32032の800-900MHzのLNAとしての応用についてご紹介します。ここでは、0.032インチ厚のFR-4のPCボードを用いて設計しています。

### 900MHz LNAの設計

このLNAは $V_{ce}$ が2.7V、 $I_c$ が5 mAで設計されているため、3Vの電源電圧で使用可能です。図16は900MHz LNAの回路図で、図17は部品表です。

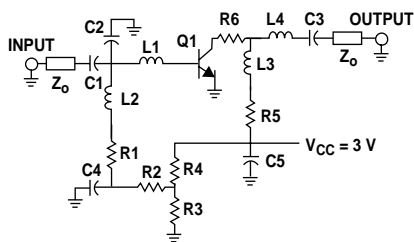

Figure 16. Schematic Diagram.

C1,C3	10 pF chip capacitor
C2	Open circuited stub .275 inch long
C4,C5	1000 pF chip capacitor
L1	8 nH chip inductor (Coilcraft 1008CS-080)
L2	Optional (see R1)
L3	56 nH chip inductor (Coilcraft 1008CS-560)
L4	15 nH chip inductor (Coilcraft 1008CS-150)
Q1	Hewlett-Packard AT-32032 Silicon Bipolar Transistor
R1	10K $\Omega$ chip resistor (may want to substitute a 180 nH chip inductor and 50 W resistor for lower noise figure, better low freq stability, the readjust R2)
R2	26.1 K $\Omega$ chip resistor (adjust for rated $I_c$ )
R3	3.32 K $\Omega$ chip resistor
R4	3.32 K $\Omega$ chip resistor
R5	51.1 $\Omega$ chip resistor
R6	13 $\Omega$ chip resistor (see text)
Zo	50 $\Omega$ microstripline

Figure 17. Component Parts List.

PCボードのレイアウトと部品の位置については図18をご覧ください。

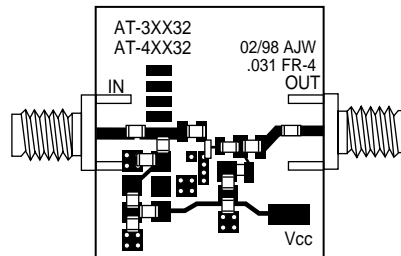

Figure 18. 1X Artwork showing Component Placement.

入力整合回路は低雑音整合にするため、並列キャパシタ(C2)と直列インダクタ(L1)で構成されています。この並列キャパシタはオープン回路スタブを用いています。また、直列インダクタはチップ・インダクタを用いています。出力整合回路は、直列チップ・インダクタ(L4)を用いています。バイアス回路はデカップリング用にインダクタ(L2,L3)を用いています。また、バイアス回路は適切にバイパス(C4,C5)されRFグランドがとられています。バイアス回路の出力側にある抵抗(R5)はバイアス回路のQを下げて、800-900MHzや低い周波数での安定性を向上しています。抵抗(R6)は広帯域の安定性を改善するもので、特に9-10GHzの周波数帯で効果があります。

### バイアス回路

バイアス回路は3Vの電源電圧で使用するよう設計されています。抵抗(R1,R2)がコレクタ電流を調整します。抵抗(R4)はR5とC5の接続された場所に接続され、バイアス点の安定性を向上します。

### 測定結果

図19はこのアンプのゲインを測定した結果です。ゲインは800-900MHzで15.5-16.5dBです。図20はNFの測定結果で

850MHzで1.1dBのNFを得ることができました。図21は入出力のリターン・ロスです。入力リターン・ロスは900MHzで7dBですが、キャパシタ(C2)の値を大きくすることにより、NFを少し犠牲にして9dBの入力リターン・ロスを得ることもできます。出力リターン・ロスは12-15dBです。

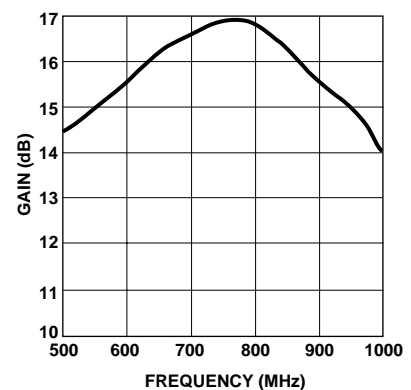

Figure 19. Gain vs Frequency.

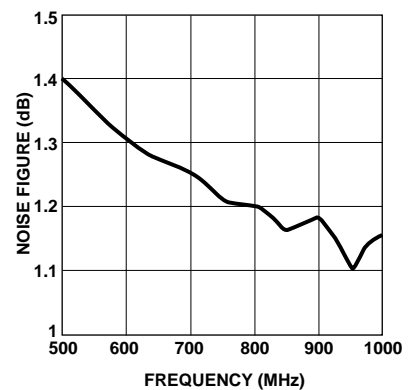
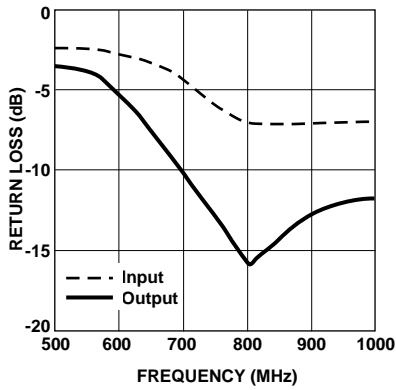

Figure 20. Noise Figure vs Frequency.



出力インターセプト・ポイント(IP<sub>3</sub>)は900MHzで+14.3dBmです。このIP<sub>3</sub>を向上させる方法は2つあります。1つめは抵抗R5とR6の値を変えることで、R5を大きくし、R6を小さくするとIP<sub>3</sub>が改善されますが、回路の安定性を犠牲にすることになります。2つめは出力整合を最小のVSWRではなく最大パワーに整合することです。

Figure 21. Input/Output Return Loss.

## Ordering Information

Part Number	Increment	Comments
AT-32032-BLK	100	Bulk
AT-32032-TR1	3000	7" Reel

## Package Dimensions

### Outline SOT-323 (SC-70 3 Lead)

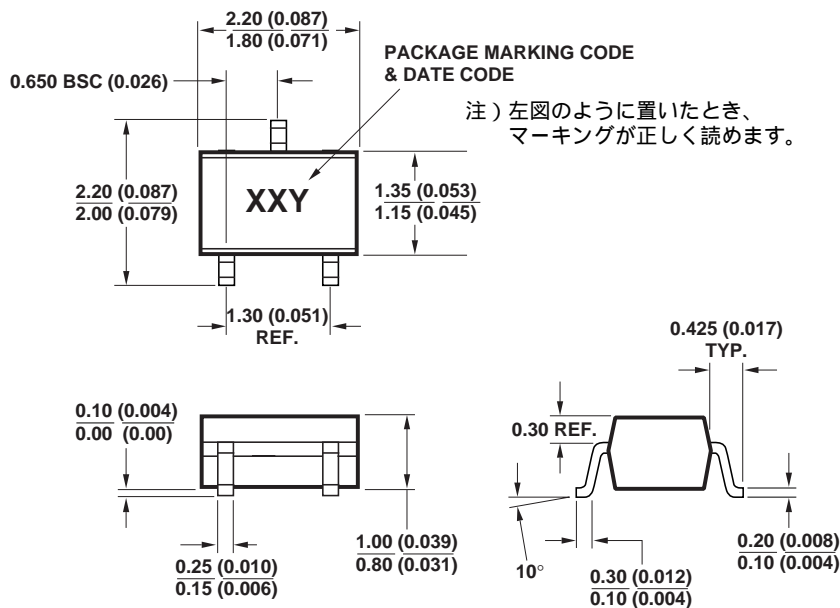

DIMENSIONS ARE IN MILLIMETERS (INCHES)

**Tape Dimensions and Device Orientation, continued**  
**For Outline SOT-323 (SC-70 3 Lead)**

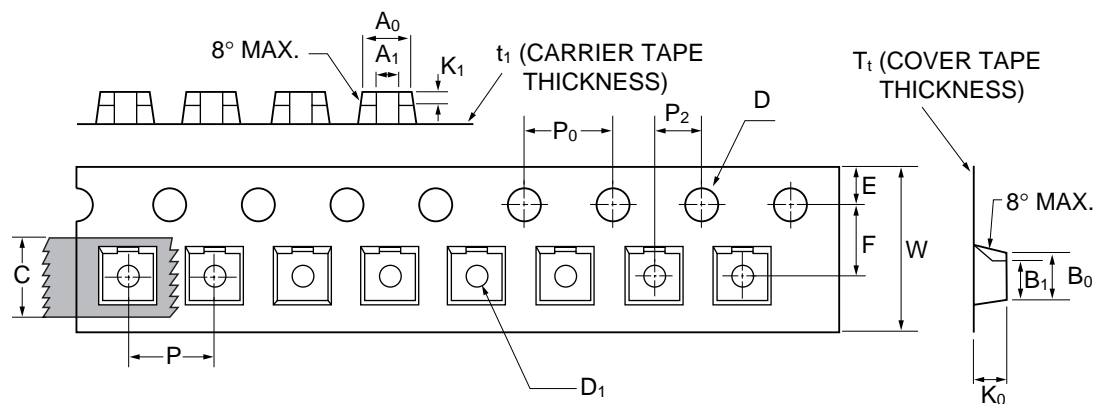

DESCRIPTION		SYMBOL	SIZE (MM)	SIZE (INCHES)
CAVITY	LENGTH	A <sub>0</sub>	2.41 ± 0.10	0.095 ± 0.004
		A <sub>1</sub>	0.99	0.039
	WIDTH	B <sub>0</sub>	2.41 ± 0.10	0.095 ± 0.004
		B <sub>1</sub>	1.91	0.075
	DEPTH	K <sub>0</sub>	1.19 ± 0.10	0.047 ± 0.004
		K <sub>1</sub>	0.05	0.020
	PITCH	P	3.99 ± 0.10	0.157 ± 0.004
	BOTTOM HOLE DIAMETER	D <sub>1</sub>	0.99 ± 0.25	0.039 ± 0.010
PERFORATION	DIAMETER	D	1.55 ± 0.05	0.061 ± 0.002
	PITCH	P <sub>0</sub>	3.99 ± 0.10	0.157 ± 0.004
	POSITION	E	1.75 ± 0.10	0.069 ± 0.004
CARRIER TAPE	WIDTH	W	8.00 ± 0.30	0.315 ± 0.012
	THICKNESS	t <sub>1</sub>	0.254 ± 0.013	0.010 ± 0.0005
COVER TAPE	WIDTH	C	5.21 ± 0.10	0.205 ± 0.004
	TAPE THICKNESS	T <sub>t</sub>	0.063 ± 0.001	0.0025 ± 0.00004
DISTANCE	CAVITY TO PERFORATION (WIDTH DIRECTION)	F	3.51 ± 0.05	0.138 ± 0.002
	CAVITY TO PERFORATION (LENGTH DIRECTION)	P <sub>2</sub>	2.01 ± 0.05	0.079 ± 0.002

## 当社半導体部品のご使用にあたって

### 仕様及び仕様書に関して

- ・本仕様は製品改善および技術改良等により予告なく変更する場合があります。ご使用の際には最新の仕様を問い合わせの上、用途のご確認をお願いいたします。
- ・本仕様記載内容を無断で転載または複写することは禁じられております。
- ・本仕様内でご紹介している応用例(アプリケーション)は当社製品がご使用できる代表的なものです。ご使用において第三者の知的財産権などの保証または実施権の許諾に対して問題が発生した場合、当社はその責任を負いかねます。
- ・仕様書はメーカーとユーザ間で交わされる製品に関する使用条件や誤使用防止事項を言及するものです。仕様書の条件外で保存、使用された場合に動作不良、機械不良が発生しても当社は責任を負いかねます。ただし、当社は納品後1年以内に当社の責任に帰すべき理由で、不良或いは故障が発生した場合、無償で製品を交換いたします。
- ・仕様書の製品が製造上および政策上の理由で満足できない場合には変更の権利を当社が有し、その交渉は当社の要求によりすみやかに行われることとさせていただきます。なお、基本的に変更は3ヶ月前、廃止は1年前にご連絡致しますが、例外もございますので予めご了承ください。

### ご使用用途に関して

- ・当社の製品は、一般的な電子機器(コンピュータ、OA機器、通信機器、AV機器、家電製品、アミューズメント機器、計測機器、一般産業機器など)の一部に組み込まれて使用されるものです。極めて高い信頼性と安全性が要求される用途(輸送機器、航空・宇宙機器、海底中継器、原子力制御システム、生命維持のための医療機器などの財産・環境もしくは生命に悪影響を及ぼす可能性を持つ用途)を意図し、設計も製造もされているものではありません。それゆえ、本製品の安全性、品質および性能に関しては、仕様書(又は、カタログ)に記載してあること以外は明示的にも黙示的にも一切の保証をするものではありません。

### 回路設計上のお願い

- ・当社は品質、信頼性の向上に努力しておりますが、一般的に半導体製品の誤動作や、故障の発生は避けられません。本製品の使用に附随し、或いはこれに関連する誤動作、故障、寿命により、他人の生命又は財産に被害や悪影響を及ぼし、或いは本製品を取り付けまたは使用した設備、施設または機械器具に故障が生じ一般公衆に被害を起こしても、当社はその内容、程度を問わず、一切の責任を負いかねます。  
お客様の責任において、装置の安全設計をお願いいたします。