

The RF Line NPN Silicon Power Transistors

... designed for 12.5 volt large-signal power amplifiers in commercial and industrial equipment.

- High Common Emitter Power Gain
- Specified 12.5 V, 175 MHz Performance
 - Output Power = 30 Watts
 - Power Gain = 10 dB
 - Efficiency = 60%
- Diffused Emitter Resistor Ballasting
- Characterized to 220 MHz
- Load Mismatch at High Line and Overdrive Conditions

MRF1946
MRF1946A

30 W, 136–220 MHz
RF POWER
TRANSISTORS
NPN SILICON

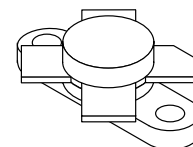

CASE 211-07, STYLE 1
MRF1946

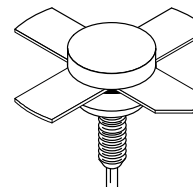

CASE 145A-09, STYLE 1
MRF1946A

MAXIMUM RATINGS

Rating	Symbol	Value	Unit
Collector–Emitter Voltage	V_{CEO}	16	Vdc
Collector–Base Voltage	V_{CBO}	36	Vdc
Emitter–Base Voltage	V_{EBO}	4.0	Vdc
Collector Current — Continuous	I_C	8.0	Adc
Total Device Dissipation @ $T_A = 25^\circ\text{C}$ Derate above 25°C	P_D	100 0.57	Watts W/ $^\circ\text{C}$
Storage Temperature Range	T_{stg}	-65 to +150	$^\circ\text{C}$
Junction Temperature	T_J	200	$^\circ\text{C}$

THERMAL CHARACTERISTICS

Characteristic	Symbol	Max	Unit
Thermal Resistance, Junction to Case	$R_{\theta JC}$	1.75	$^\circ\text{C}/\text{W}$

ELECTRICAL CHARACTERISTICS ($T_C = 25^\circ\text{C}$ unless otherwise noted.)

Characteristic	Symbol	Min	Typ	Max	Unit
----------------	--------	-----	-----	-----	------

OFF CHARACTERISTICS

Collector–Emitter Breakdown Voltage ($I_C = 25 \text{ mAdc}$, $I_B = 0$)	$V_{(BR)CEO}$	16	—	—	Vdc
Collector–Emitter Breakdown Voltage ($I_C = 25 \text{ mAdc}$, $V_{BE} = 0$)	$V_{(BR)CES}$	36	—	—	Vdc
Emitter–Base Breakdown Voltage ($I_E = 5.0 \text{ mAdc}$, $I_C = 0$)	$V_{(BR)EBO}$	4.0	—	—	Vdc
Collector Cutoff Current ($V_{CE} = 15 \text{ Vdc}$, $V_{BE} = 0$, $T_C = 25^\circ\text{C}$)	I_{CES}	—	—	5.0	mAdc

ON CHARACTERISTICS

DC Current Gain ($I_C = 1.0 \text{ Adc}$, $V_{CE} = 5.0 \text{ Vdc}$)	h_{FE}	40	75	150	—
---	----------	----	----	-----	---

(continued)

ELECTRICAL CHARACTERISTICS — continued ($T_C = 25^\circ\text{C}$ unless otherwise noted.)

Characteristic	Symbol	Min	Typ	Max	Unit
DYNAMIC CHARACTERISTICS					
Output Capacitance ($V_{CB} = 15\text{ Vdc}$, $I_E = 0$, $f = 1.0\text{ MHz}$)	C_{ob}	—	75	100	pF
FUNCTIONAL TESTS					
Common-Emitter Amplifier Power Gain ($V_{CC} = 12.5\text{ Vdc}$, $P_{out} = 30\text{ W}$, $f = 175\text{ MHz}$)	G_{pe}	10	11	—	dB
Collector Efficiency ($V_{CC} = 12.5\text{ Vdc}$, $P_{out} = 30\text{ W}$, $f = 175\text{ MHz}$)	η	60	70	—	%
Load Mismatch ($V_{CC} = 15.5\text{ Vdc}$, $P_{in} = 2.0\text{ dB Overdrive}$, Load VSWR = 30:1)	ψ	No Degradation in Power Output			

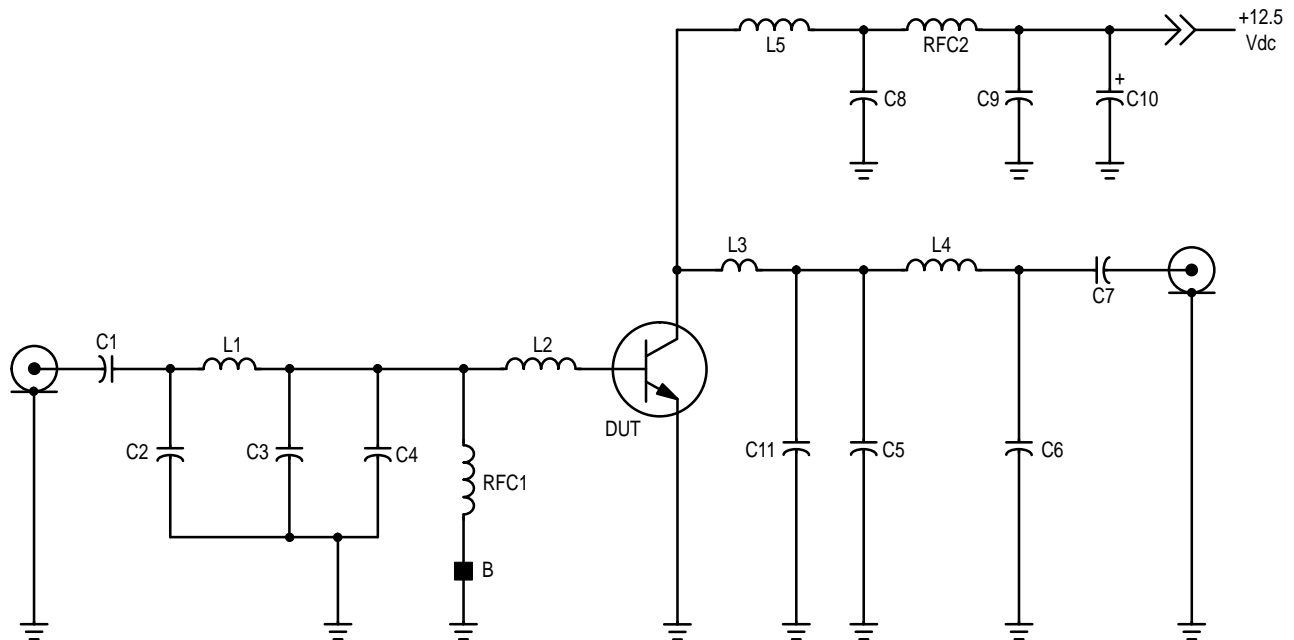

- C1 — 56 pF Mini-Unelco, 3HS0006-56
- C2 — 47 pF Mini-Unelco, 3HS0006-47
- C3, C4 — 180 pF Chip Cap, ATC 100B181JC500
- C5 — 150 pF Unelco, J101-150
- C6 — 39 pF Mini-Unelco, 3HS0006-39
- C7, C8 — 1000 pF Chip Cap, ATC 100B102JC50
- C9 — 0.1 μF Ceramic Capacitor
- C10 — 10 μF , 25 V Electrolytic Capacitor
- C11 — 56 pF Mini-Unelco, 3HS0006-56
- L1 — 2 Turns #18 AWG, 0.125" ID
- L2, L3 — Circuit Board and Mounting Pad Inductance
- L4 — 3 Turns #18 AWG, 0.125" ID
- L5 — 6 Turns #16 Enameled, 0.250" ID
- RFC1 — 0.15 μH Molded Choke w/Ferrite Bead
- RFC2 — Ferrite Choke, Fair Rite VK200-4B
- Board Material — 1/32, Glass Teflon, 1 oz. Cu Plating
- Bead — Ferroxcube

Figure 1. Broadband Test Circuit Schematic

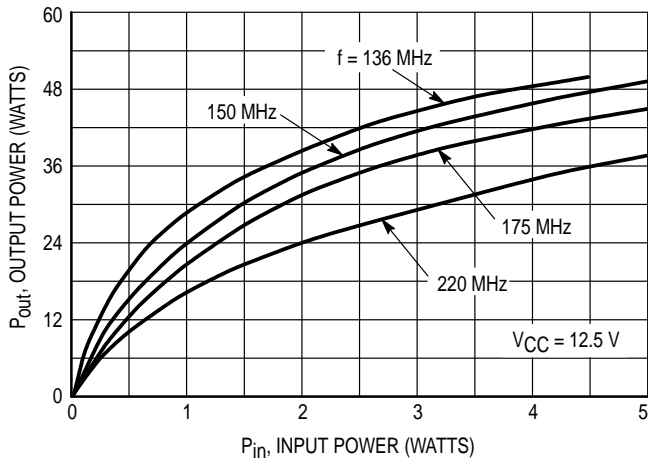

Figure 2. Output Power versus Input Power

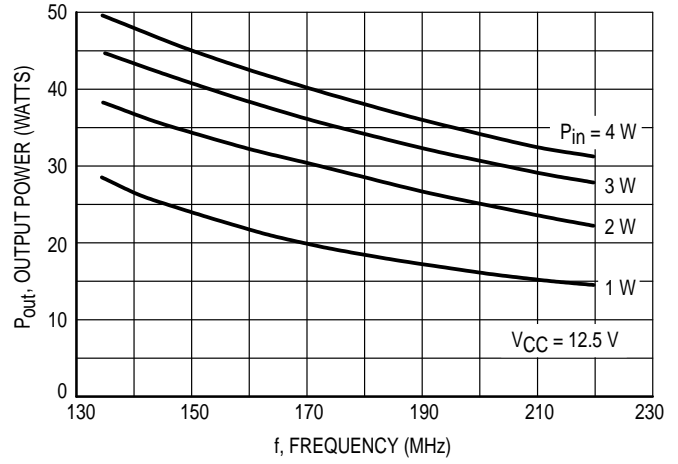

Figure 3. Output Power versus Frequency

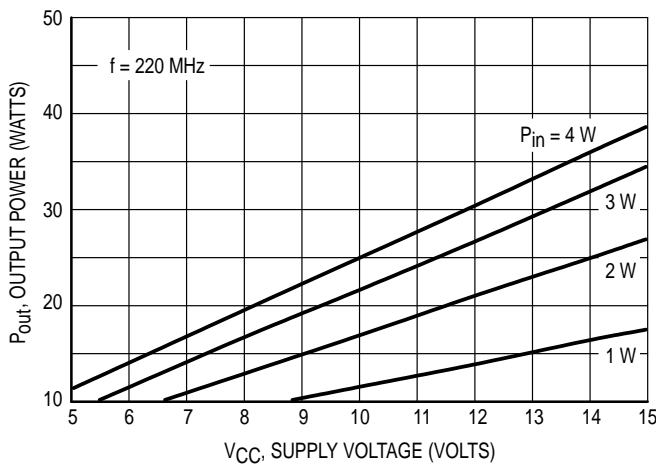

Figure 4. Output Power versus Supply Voltage

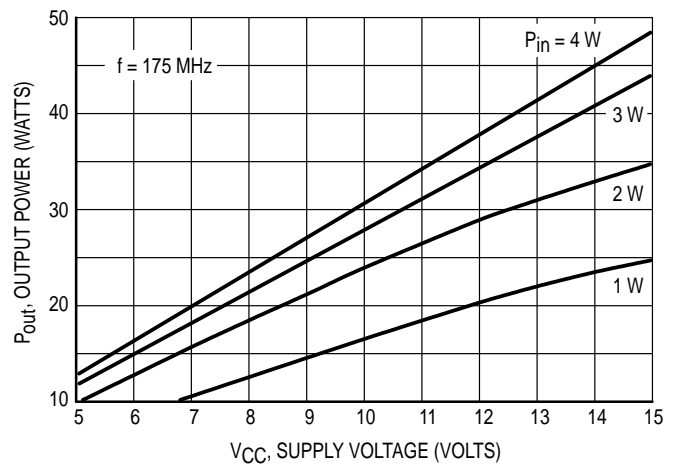

Figure 5. Output Power versus Supply Voltage

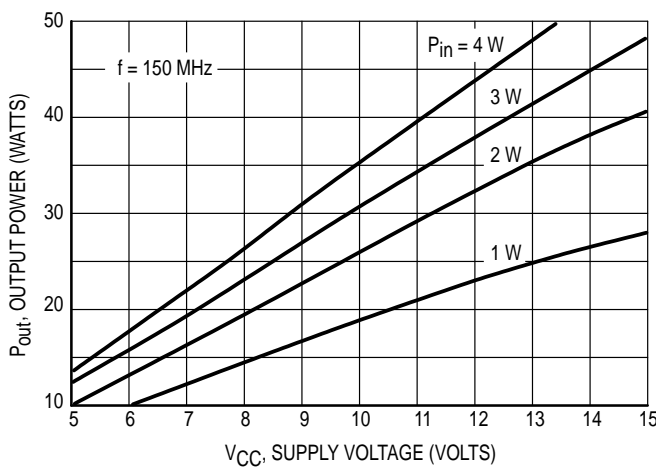

Figure 6. Output Power versus Supply Voltage

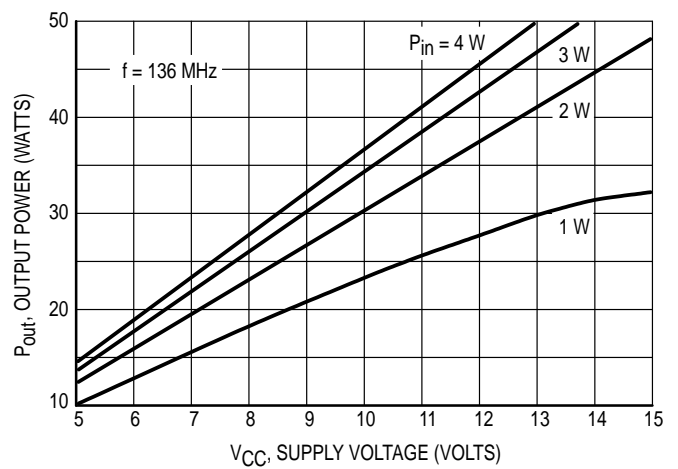

Figure 7. Output Power versus Supply Voltage

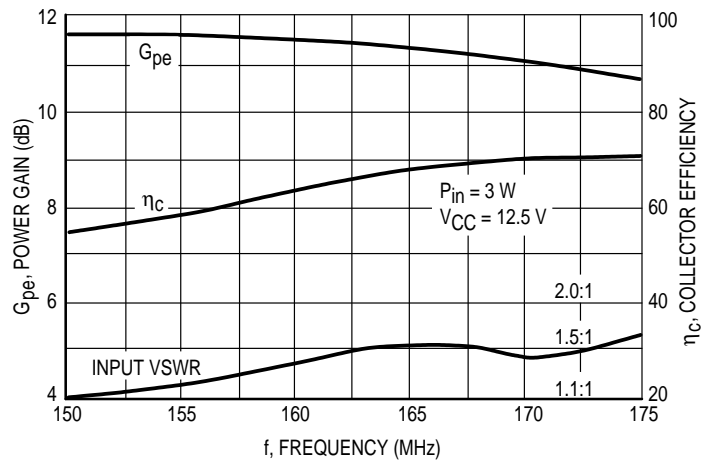
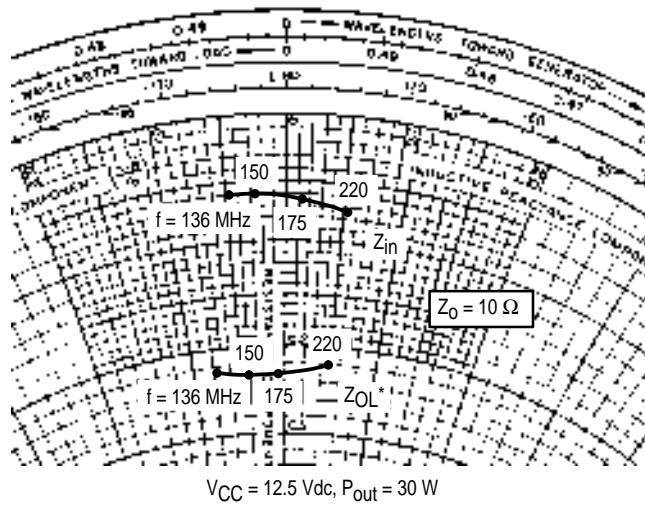

Figure 8. Typical Performance in a Broadband Circuit



f MHz	Z_{in} Ohms	Z_{OL}^* Ohms
136	$0.60 - j0.48$	$2.22 - j0.74$
150	$0.63 - j0.26$	$2.30 - j0.40$
175	$0.62 + j0.13$	$2.35 - j0.04$
220	$0.73 + j0.57$	$2.20 + j0.43$

Z_{OL}^* = Conjugate of the optimum load impedance into which the device output operates at a given output power, voltage and frequency.

Figure 9. Series Equivalent Input and Output Impedance

PACKAGE DIMENSIONS

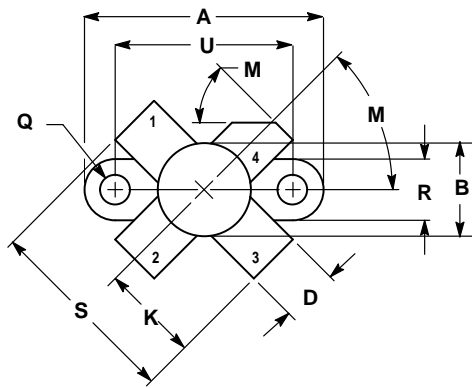

- NOTES:
 1. DIMENSIONING AND TOLERANCING PER ANSI Y14.5M, 1982.
 2. CONTROLLING DIMENSION: INCH.

DIM	INCHES		MILLIMETERS	
	MIN	MAX	MIN	MAX
A	0.960	0.990	24.39	25.14
B	0.370	0.390	9.40	9.90
C	0.229	0.281	5.82	7.13
D	0.215	0.235	5.47	5.96
E	0.085	0.105	2.16	2.66
H	0.150	0.108	3.81	4.57
J	0.004	0.006	0.11	0.15
K	0.395	0.405	10.04	10.28
M	40°	50°	40°	50°
Q	0.113	0.130	2.88	3.30
R	0.245	0.255	6.23	6.47
S	0.790	0.810	20.07	20.57
U	0.720	0.730	18.29	18.54

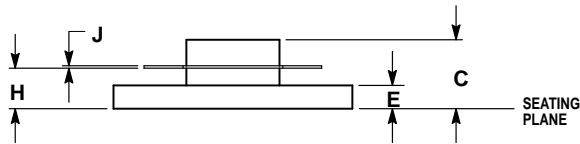

- STYLE 1:
 PIN 1. EMITTER
 2. BASE
 3. EMITTER
 4. COLLECTOR

**CASE 211-07
 ISSUE N
 MRF1946**

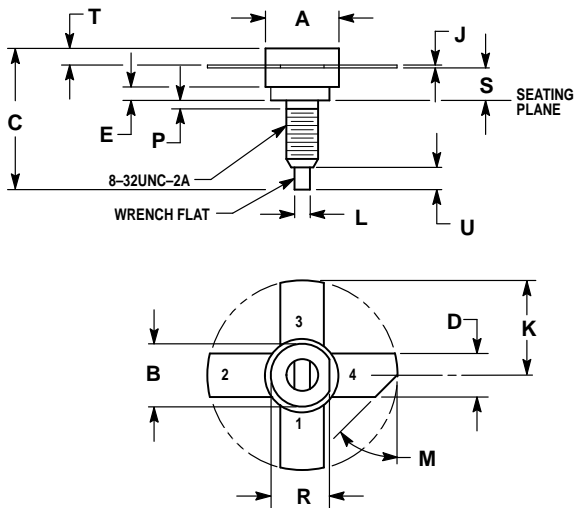

- NOTES:
 1. DIMENSIONING AND TOLERANCING PER ANSI Y14.5M, 1982.
 2. CONTROLLING DIMENSION: INCH.

DIM	INCHES		MILLIMETERS	
	MIN	MAX	MIN	MAX
A	0.370	0.385	9.40	9.78
B	0.320	0.330	8.13	8.38
C	0.670	0.790	17.02	20.07
D	0.215	0.235	5.46	5.97
E	0.070	—	1.78	—
J	0.003	0.007	0.08	0.18
K	0.490	—	12.45	—
L	0.055	0.070	1.40	1.78
M	45°NOM	—	45°NOM	—
P	—	0.050	—	1.27
R	0.299	0.307	7.59	7.80
S	0.158	0.178	4.01	4.52
T	0.083	0.100	2.11	2.54
U	0.098	0.132	2.49	3.35

- STYLE 1:
 PIN 1. EMITTER
 2. BASE
 3. EMITTER
 4. COLLECTOR

**CASE 145A-09
 ISSUE M
 MRF1946A**

Motorola reserves the right to make changes without further notice to any products herein. Motorola makes no warranty, representation or guarantee regarding the suitability of its products for any particular purpose, nor does Motorola assume any liability arising out of the application or use of any product or circuit, and specifically disclaims any and all liability, including without limitation consequential or incidental damages. "Typical" parameters can and do vary in different applications. All operating parameters, including "Typicals" must be validated for each customer application by customer's technical experts. Motorola does not convey any license under its patent rights nor the rights of others. Motorola products are not designed, intended, or authorized for use as components in systems intended for surgical implant into the body, or other applications intended to support or sustain life, or for any other application in which the failure of the Motorola product could create a situation where personal injury or death may occur. Should Buyer purchase or use Motorola products for any such unintended or unauthorized application, Buyer shall indemnify and hold Motorola and its officers, employees, subsidiaries, affiliates, and distributors harmless against all claims, costs, damages, and expenses, and reasonable attorney fees arising out of, directly or indirectly, any claim of personal injury or death associated with such unintended or unauthorized use, even if such claim alleges that Motorola was negligent regarding the design or manufacture of the part. Motorola and  are registered trademarks of Motorola, Inc. Motorola, Inc. is an Equal Opportunity/Affirmative Action Employer.

How to reach us:

USA / EUROPE: Motorola Literature Distribution;
P.O. Box 20912; Phoenix, Arizona 85036. 1-800-441-2447

JAPAN: Nippon Motorola Ltd.; Tatsumi-SPD-JLDC, Toshikatsu Otsuki,
6F Seibu-Butsuryu-Center, 3-14-2 Tatsumi Koto-Ku, Tokyo 135, Japan. 03-3521-8315

MFAX: RMFAX0@email.sps.mot.com - TOUCHTONE (602) 244-6609
INTERNET: <http://Design-NET.com>

HONG KONG: Motorola Semiconductors H.K. Ltd.; 8B Tai Ping Industrial Park,
51 Ting Kok Road, Tai Po, N.T., Hong Kong. 852-26629298



MRF1946/D

