

Smart Highside Power Switch

Features

- Overload protection
- Current limitation
- Short circuit protection
- Thermal shutdown
- Overvoltage protection (including load dump)
- Fast demagnetization of inductive loads
- Reverse battery protection¹⁾
- Undervoltage and overvoltage shutdown with auto-restart and hysteresis
- Open drain diagnostic output
- Open load detection in ON-state
- CMOS compatible input
- Loss of ground and loss of V_{bb} protection
- Electrostatic discharge (ESD) protection

Product Summary

Overvoltage protection	$V_{bb(AZ)}$	65 V
Operating voltage	$V_{bb(on)}$	4.7 ... 42 V
On-state resistance	R_{ON}	220 mΩ
Load current (ISO)	$I_L(ISO)$	1.8 A
Current limitation	$I_L(SCR)$	2.7 A

Application

- μ C compatible power switch with diagnostic feedback for 12 V and 24 V DC grounded loads
- Most suitable for inductive loads
- Replaces electromechanical relays and discrete circuits

General Description

N channel vertical power FET with charge pump, ground referenced CMOS compatible input and diagnostic feedback, monolithically integrated in Smart SIPMOS® technology. Fully protected by embedded protection functions.

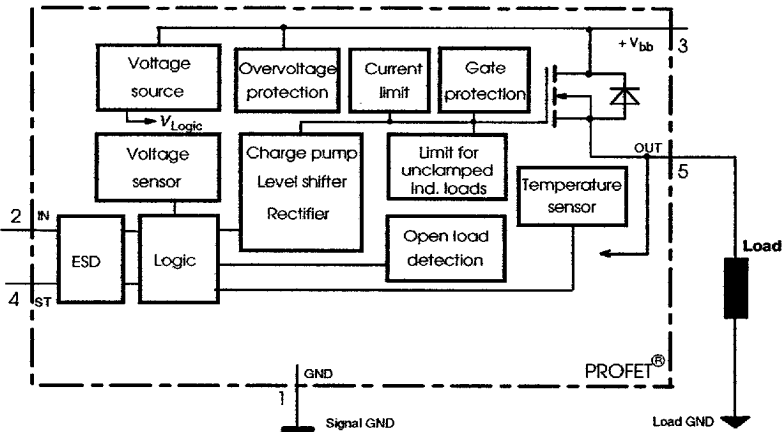
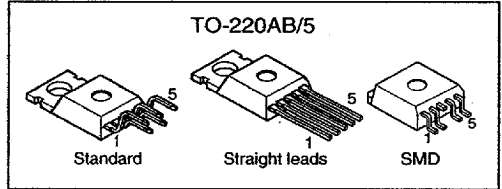

1) With external current limit (e.g. resistor $R_{GND}=150 \Omega$) in GND connection, resistors in series with IN and ST connections, reverse load current limited by connected load.

Pin	Symbol		Function
1	GND	-	Logic ground
2	IN	I	Input, activates the power switch in case of logical high signal
3	V _{bb}	+	Positive power supply voltage, the tab is shorted to this pin
4	ST	S	Diagnostic feedback, low on failure
5	OUT (Load, L)	O	Output to the load

Maximum Ratings at $T_j = 25\text{ °C}$ unless otherwise specified

Parameter	Symbol	Values	Unit	
Supply voltage (overvoltage protection see page 450)	V_{bb}	65	V	
Load dump protection ²⁾ $V_{LoadDump} = U_A + V_S$, $U_A = 13.5\text{ V}$ $R_i^{3)} = 2\ \Omega$, $R_L = 6.6\ \Omega$, $t_d = 400\text{ ms}$, IN= low or high	$V_{Load\ dump}^{4)}$	100	V	
Load current (Short circuit current, see page 451)	I_L	self-limited	A	
Operating temperature range	T_j	-40 ... +150	°C	
Storage temperature range	T_{stg}	-55 ... +150	°C	
Power dissipation (DC), $T_C \leq 25\text{ °C}$	P_{tot}	50	W	
Inductive load switch-off energy dissipation, single pulse $T_j = 150\text{ °C}$:	E_{AS}	tbd	J	
Electrostatic discharge capability (ESD) (Human Body Model)	V_{ESD}	1	kV	
Input voltage (DC)	V_{IN}	-0.5 ... +6	V	
Current through input pin (DC)	I_{IN}	±5.0	mA	
Current through status pin (DC)	I_{ST}	±5.0	mA	
see internal circuit diagrams page 453				
Thermal resistance	chip - case: junction - ambient (free air): SMD version, device on PCB ⁵⁾ :	R_{thJC} R_{thJA}	≤ 2.5 ≤ 75 ≤ tbd	K/W

2) Supply voltages higher than $V_{bb(AZ)}$ require an external current limit for the GND and status pins, e.g. with a 150 Ω resistor in the GND connection and a 15 k Ω resistor in series with the status pin. A resistor for the protection of the input is integrated.

3) R_i = internal resistance of the load dump test pulse generator

4) $V_{Load\ dump}$ is setup without the DUT connected to the generator per ISO 7637-1 and DIN 40839

5) Device on 50mm*50mm*1.5mm epoxy PCB FR4 with 6cm² (one layer, 70 μ m thick) copper area for V_{bb} connection. PCB is vertical without blown air.

Electrical Characteristics

Parameter and Conditions at $T_j = 25\text{ }^\circ\text{C}$, $V_{bb} = 12\text{ V}$ unless otherwise specified	Symbol	Values			Unit
		min	typ	max	

Load Switching Capabilities and Characteristics

On-state resistance (pin 3 to 5) $I_L = 1.6\text{ A}$	$T_j = 25\text{ }^\circ\text{C}$: $T_j = 150\text{ }^\circ\text{C}$:	R_{ON}	--	190 390	220 440	m Ω
Nominal load current (pin 3 to 5) ISO Proposal: $V_{ON} = 0.5\text{ V}$, $T_C = 85\text{ }^\circ\text{C}$		$I_{L(ISO)}$	1.6	1.8	--	A
Output current (pin 5) while GND disconnected or GND pulled up, $V_{bb} = 30\text{ V}$, $V_{IN} = 0$, see diagram page 454, $T_j = -40\dots+150\text{ }^\circ\text{C}$		$I_{L(GNDhigh)}$	--	--	10	mA
Turn-on time to 90% V_{OUT} :		t_{on}	12	--	125	μs
Turn-off time to 10% V_{OUT} :		t_{off}	5	--	85	μs
Slew rate on 10 to 30% V_{OUT} , $R_L = 12\text{ }\Omega$, $T_j = -40\dots+150\text{ }^\circ\text{C}$		dV/dt_{on}	--	--	3	V/ μs
Slew rate off 70 to 40% V_{OUT} , $R_L = 12\text{ }\Omega$, $T_j = -40\dots+150\text{ }^\circ\text{C}$		$-dV/dt_{off}$	--	--	6	V/ μs

Operating Parameters

Operating voltage ⁶⁾	$T_j = -40\dots+150\text{ }^\circ\text{C}$:	$V_{bb(on)}$	4.7	--	42	V
Undervoltage shutdown	$T_j = 25\text{ }^\circ\text{C}$:	$V_{bb(under)}$	2.9	--	4.5	V
	$T_j = -40\dots+150\text{ }^\circ\text{C}$:		2.7	--	4.7	V
Undervoltage restart	$T_j = -40\dots+150\text{ }^\circ\text{C}$:	$V_{bb(u\text{ rst})}$	--	--	4.9	V
Undervoltage restart of charge pump see diagram page 458		$V_{bb(ucp)}$	--	5.6	6.0	V
Undervoltage hysteresis $\Delta V_{bb(under)} = V_{bb(u\text{ rst})} - V_{bb(under)}$		$\Delta V_{bb(under)}$	--	0.1	--	V
Overvoltage shutdown	$T_j = -40\dots+150\text{ }^\circ\text{C}$:	$V_{bb(over)}$	42	--	52	V
Overvoltage restart	$T_j = -40\dots+150\text{ }^\circ\text{C}$:	$V_{bb(o\text{ rst})}$	40	--	--	V
Overvoltage hysteresis	$T_j = -40\dots+150\text{ }^\circ\text{C}$:	$\Delta V_{bb(over)}$	--	0.1	--	V
Overvoltage protection ⁷⁾ $I_{bb} = 4\text{ mA}$	$T_j = -40\dots+150\text{ }^\circ\text{C}$:	$V_{bb(AZ)}$	65	70	--	V
Standby current (pin 3) $V_{IN} = 0$	$T_j = -40\dots+25\text{ }^\circ\text{C}$:	$I_{bb(off)}$	--	10	15	μA
	$T_j = 150\text{ }^\circ\text{C}$:		--	18	25	μA
Leakage output current (included in $I_{bb(off)}$) $V_{IN} = 0$		$I_{L(off)}$	--	--	20	μA

⁶⁾ At supply voltage increase up to $V_{bb} = 5.6\text{ V}$ typ without charge pump, $V_{OUT} \approx V_{bb} - 2\text{ V}$

⁷⁾ Measured without load. See also $V_{ON(CL)}$ in table of protection functions and circuit diagram page 454.

Parameter and Conditions at $T_j = 25^\circ\text{C}$, $V_{bb} = 12\text{ V}$ unless otherwise specified	Symbol	Values			Unit
		min	typ	max	
Operating current (Pin 1) ⁸⁾ , $V_{IN}=5\text{ V}$, $T_j=-40\dots+150^\circ\text{C}$	I_{GND}	--	1	2.1	mA

Protection Functions

Initial peak short circuit current limit (pin 3 to 5) $T_j = -40^\circ\text{C}$: $T_j = 25^\circ\text{C}$: $T_j = +150^\circ\text{C}$:	$I_{L(SCP)}$	4.0	--	11	A
		3.5	5.5	10	
		2.0	3.5	7.5	
Repetitive short circuit shutdown current limit $T_j = T_{jt}$ (see timing diagrams, page 457)	$I_{L(SCr)}$	--	2.7	--	A
Output clamp (inductive load switch off) at $V_{OUT} = V_{bb} - V_{ON(CL)}$ $I_L = 40\text{ mA}$, $T_j = -40\dots+150^\circ\text{C}$: $I_L = 1\text{ A}$, $T_j = -40\dots+150^\circ\text{C}$:	$V_{ON(CL)}$	61	68	73	V
		--	--	75	
Thermal overload trip temperature	T_{jt}	150	--	--	$^\circ\text{C}$
Thermal hysteresis	ΔT_{jt}	--	10	--	K
Inductive load switch-off energy dissipation ⁹⁾ , $T_{j\text{start}} = 150^\circ\text{C}$, single pulse $V_{bb} = 12\text{ V}$: $V_{bb} = 24\text{ V}$:	E_{AS}	--	--	tbd	J
	E_{Load12}			tbd	
	E_{Load24}			tbd	
Reverse battery (pin 3 to 1) ¹⁰⁾	$-V_{bb}$	--	--	32	V

Diagnostic Characteristics

Open load detection current (on-condition) $T_j = -40\dots+150^\circ\text{C}$:	$I_{L(OL)}$	2	--	150	mA
---	-------------	---	----	-----	----



⁸⁾ Add I_{ST} , if $I_{ST} > 0$, add I_{IN} , if $V_{IN} > 5.5\text{ V}$

⁹⁾ While demagnetizing load inductance, dissipated energy in PROFET is $E_{AS} = \int V_{ON(CL)} \cdot I_L(t) dt$, approx.

$$E_{AS} = \frac{1}{2} \cdot L \cdot I_L^2 \cdot \left(\frac{V_{ON(CL)}}{V_{ON(CL)} - V_{bb}} \right), \text{ see diagram page 455}$$

¹⁰⁾ Requires $150\ \Omega$ resistor in GND connection. Reverse load current (through intrinsic drain-source diode) is normally limited by the connected load. Input and Status currents have to be limited (see max. ratings page 449 and circuit page 454).

SIEMENS**BTS 410 G2**

Parameter and Conditions at $T_j = 25\text{ }^\circ\text{C}$, $V_{bb} = 12\text{ V}$ unless otherwise specified	Symbol	Values			Unit
		min	typ	max	
Input and Status Feedback¹⁾					
Input turn-on threshold voltage  $T_j = -40\dots+150\text{ }^\circ\text{C}$:	$V_{IN(T+)}$	1.5	--	2.4	V
Input turn-off threshold voltage  $T_j = -40\dots+150\text{ }^\circ\text{C}$:	$V_{IN(T-)}$	1.0	--	--	V
Input threshold hysteresis	$\Delta V_{IN(T)}$	--	0.5	--	V
Off state input current (pin 2), $V_{IN} = 0.4\text{ V}$	$I_{N(off)}$	1	--	30	μA
On state input current (pin 2), $V_{IN} = 5\text{ V}$	$I_{N(on)}$	10	25	70	μA
Status invalid after positive input slope (open load) $T_j = -40\dots+150\text{ }^\circ\text{C}$:	$t_{d(ST)}$	300	--	1400	μs
Status output (open drain)					
Zener limit voltage $T_j = -40\dots+150\text{ }^\circ\text{C}$, $I_{ST} = +50\text{ }\mu\text{A}$:	$V_{ST(high)}$	5.0	6	--	V
ST low voltage $T_j = -40\dots+150\text{ }^\circ\text{C}$, $I_{ST} = +1.6\text{ mA}$:	$V_{ST(low)}$	--	--	0.4	

¹⁾ If a ground resistor R_{GND} is used, add the voltage drop across this resistor.

Truth Table

	Input-level	Output-level	Status				
			412 B2	410 D2	410 E2/F2	410 G2	410 H2
Normal operation	L	L	H	H	H	H	H
Open load	H	H	H	H	H	H	H
	L	H ¹²⁾	L	H	H	H	L
Short circuit to GND	H	H	H	L	L	L	H
	L	L	H	H	H	H	H
Short circuit to V _{bb}	H	H	L	H (L ¹³⁾)	H (L ¹³⁾)	H (L ¹³⁾)	L
	L	L	L	L	L	L	L
Overtemperature	H	L	L	L	L	L	L
	L	L	L	L	L	L	L
Under-voltage	L	L	L ¹⁴⁾	L ¹⁴⁾	H	H	H
	H	L	L ¹⁴⁾	L ¹⁴⁾	H	H	H
Overvoltage	L	L	L	L	H	H	H
	H	L	L	L	H	H	H

L = "Low" Level
H = "High" Level

Terms

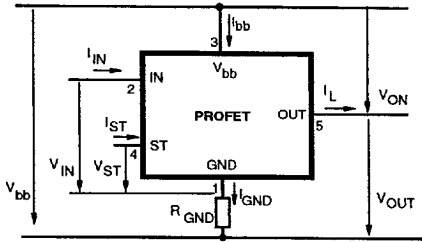

Input circuit (ESD protection)

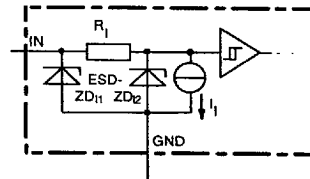

ZD11 6 V typ., ESD zener diodes are not to be used as voltage clamp at DC conditions. Operation in this mode may result in a drift of the zener voltage (increase of up to 1 V).

¹²⁾ Power Transistor off, high impedance, versions BTS 410H, BTS 412B: internal pull up current source for open load detection.

¹³⁾ Low resistance short V_{bb} to output may be detected by no-load-detection

¹⁴⁾ No current sink capability during undervoltage shutdown

Status output

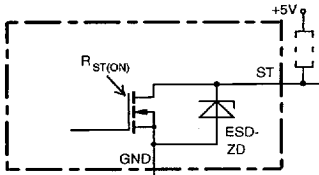

ESD-Zener diode: 6 V typ., max 5 mA;
 $R_{ST(ON)} < 250 \Omega$ at 1.6 mA, ESD zener diodes are not to be used as voltage clamp at DC conditions. Operation in this mode may result in a drift of the zener voltage (increase of up to 1 V).

Inductive and overvoltage output clamp

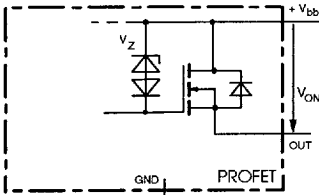

V_{ON} clamped to 68 V typ.

Overvolt. and reverse batt. protection

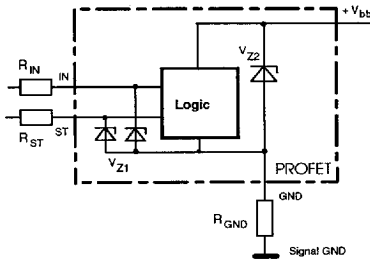

$V_{Z1} = 6.2 \text{ V typ.}$, $V_{Z2} = 70 \text{ V typ.}$, $R_{GND} = 150 \Omega$, R_{IN} , $R_{ST} = 15 \text{ k}\Omega$

Open-load detection

ON-state diagnostic condition: $V_{ON} < R_{ON} \cdot I_{L(OL)}$; IN high

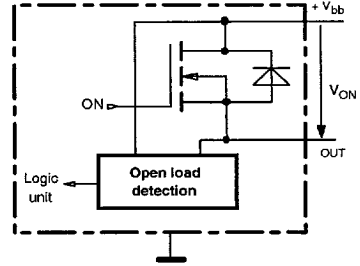

GND disconnect

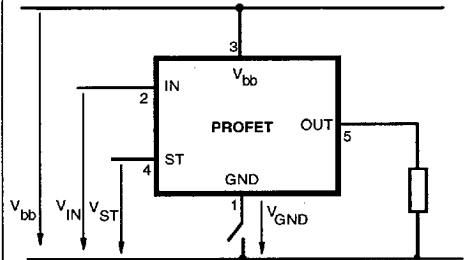

Any kind of load. In case of Input=high is $V_{OUT} = V_{IN} - V_{IN(T+)}$. Due to $V_{GND} > 0$, no V_{ST} = low signal available.

GND disconnect with GND pull up

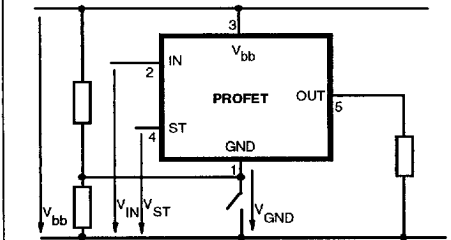

Any kind of load. If $V_{GND} > V_{IN} - V_{IN(T+)}$ device stays off. Due to $V_{GND} > 0$, no V_{ST} = low signal available.

V_{bb} disconnect with charged inductive load

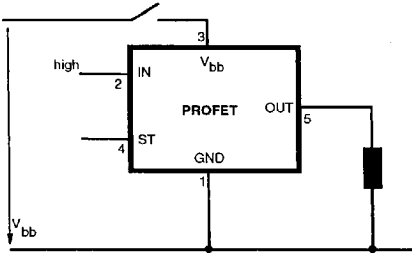

Normal load current can be handled by the PROFET itself.

V_{bb} disconnect with charged external inductive load

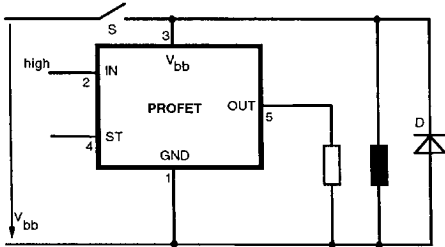

If other external inductive loads L are connected to the PROFET, additional elements like D are necessary.

Inductive Load switch-off energy dissipation

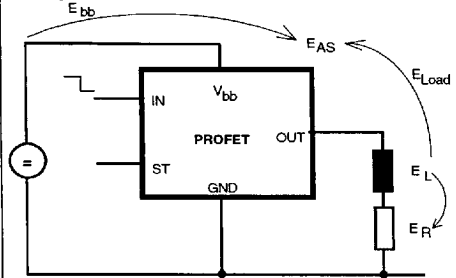

Energy dissipated in PROFET $E_{AS} = E_{bb} + E_L - E_R$.

$$E_{Load} < E_L, E_L = \frac{1}{2} \cdot L \cdot I_L^2$$

Options Overview

all versions: High-side switch, Input protection, ESD protection, load dump and reverse battery protection with 150 Ω in GND connection, protection against loss of ground

Type	BTS	412 B2	410D2	410E2	410F2	410G2	410H2
Logic version		B	D	E	F	G	H
Overtemperature protection with hysteresis							
$T_j > 150\text{ °C}$, latch function ^{15),16)}		X	X		X		X
$T_j > 150\text{ °C}$, with auto-restart on cooling				X		X	
Short circuit to GND protection							
switches off when $V_{ON} > 3.5\text{ V typ.}$ and $V_{bb} > 7\text{ V typ.}$ ¹⁵⁾ (when first turned on after approx. 150 μs)							X
switches off when $V_{ON} > 8.5\text{ V typ.}$ ¹⁵⁾ (when first turned on after approx. 150 μs)		X	X	X	X		
Achieved through overtemperature protection						X	
Open load detection							
in OFF-state with sensing current 30 μA typ.		X					X
in ON-state with sensing voltage drop across power transistor			X	X	X	X	
Undervoltage shutdown with auto restart		X	X	X	X	X	X
Overvoltage shutdown with auto restart ¹⁷⁾		X	X	X	X	X	X
Status feedback for							
overtemperature		X	X	X	X	X	X
short circuit to GND		X	X	X	X	-	X
short to V_{bb}		X	- ¹⁸⁾	- ¹⁸⁾	- ¹⁸⁾	- ¹⁸⁾	X
open load		X	X	X	X	X	X
undervoltage		X	X	-	-	-	-
overvoltage		X	X	-	-	-	-
Status output type							
CMOS		X	X				
Open drain				X	X	X	X
Output negative voltage transient limit (fast inductive load switch off)							
to $V_{bb} - V_{ON(CL)}$		X	X	X	X	X	X
Load current limit							
high level (can handle loads with high inrush currents)		X	X	X			
low level (better protection of application)					X	X	X
Protection against loss of GND		X	X	X	X	X	X

¹⁵⁾ Latch except when $V_{bb} - V_{OUT} < V_{ON(SC)}$ after shutdown. In most cases $V_{OUT} = 0\text{ V}$ after shutdown ($V_{OUT} \neq 0\text{ V}$ only if forced externally). So the device remains latched unless $V_{bb} < V_{ON(SC)}$ (see page 451). No latch between turn on and $t_{d(SC)}$.

¹⁶⁾ With latch function. Reseted by a) Input low, b) Undervoltage

¹⁷⁾ No auto restart after overvoltage in case of short circuit

¹⁸⁾ Low resistance short V_{bb} to output may be detected by no-load-detection

Timing diagrams

Figure 1a: V_{bb} turn on:

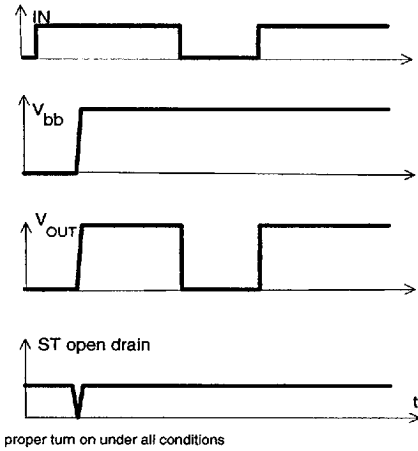

Figure 2a: Switching an inductive load

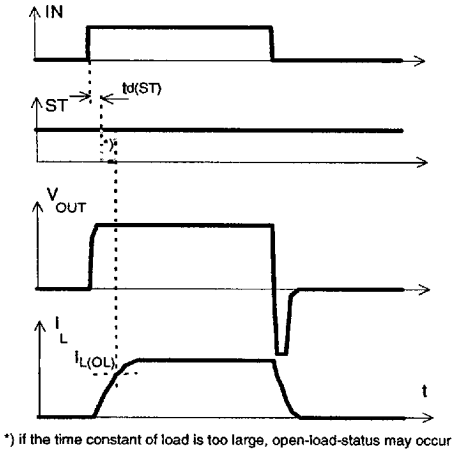

Figure 3a: Turn on into overload, Short circuit shut down by overtemperature, reset by cooling

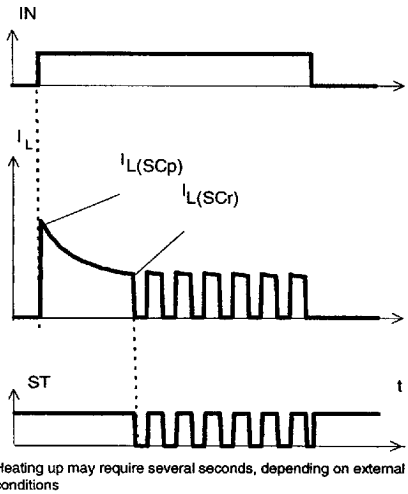

Figure 4a: Overtemperature: Reset if $T_j < T_{jt}$

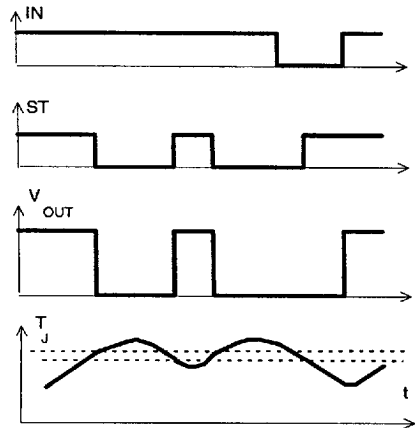

Figure 5a: Open load: detection in ON-state, turn on/off to open load

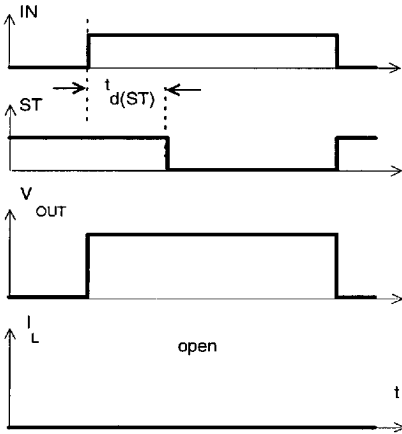

Figure 5b: Open load: detection in ON-state, open load occurs in on-state

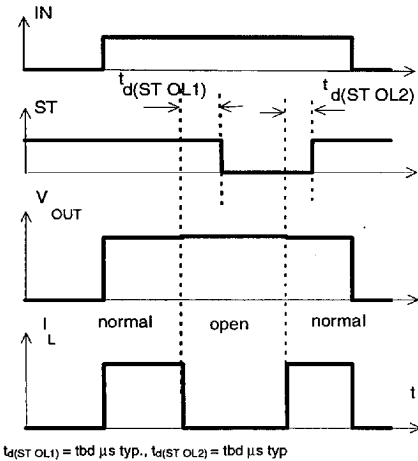

Figure 6a: Undervoltage:

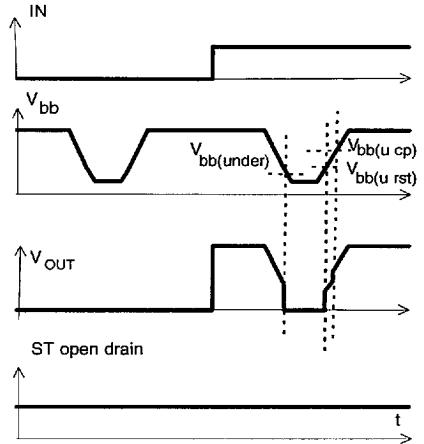

Figure 6b: Undervoltage restart of charge pump

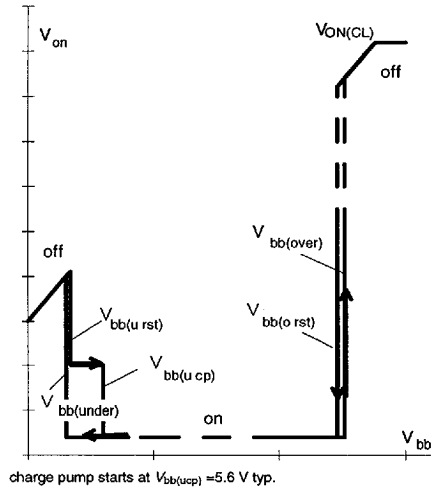

Figure 7a: Overvoltage:

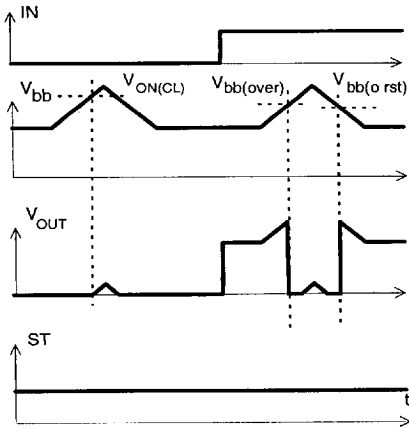
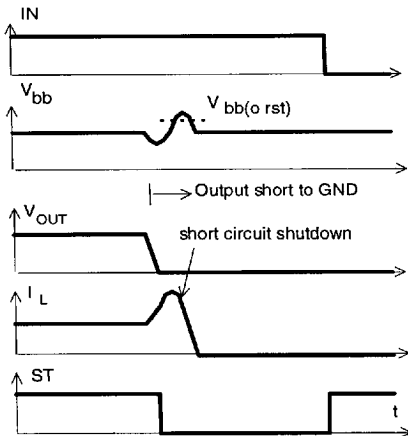

Figure 9a: Overvoltage at short circuit shutdown:



Overvoltage due to power line inductance. No overvoltage auto-restart of PROFET after short circuit shutdown.

Package and Ordering Code

All dimensions in mm

Standard TO-220AB/5

Ordering code

BTS 410 G2	Q67060-S6104-A2
------------	-----------------

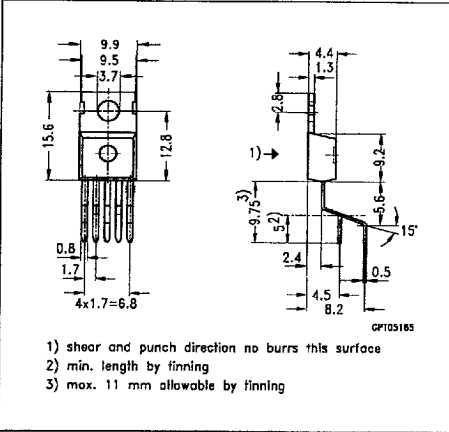

TO-220AB/5, Option E3043

Ordering code

BTS 410 G2 E3043	Q67060-S6104-A3
------------------	-----------------

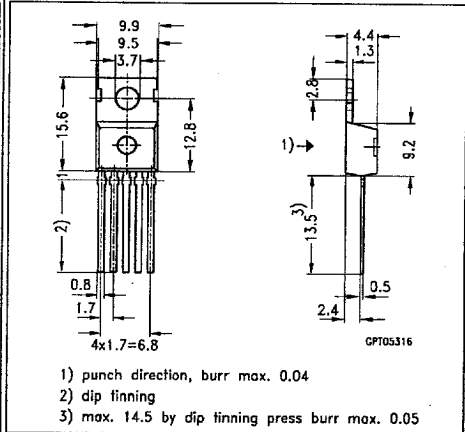

SMD TO-220AB/5, Opt. E3062

Ordering code

BTS410G2 E3062A	T&R: Q67060-S6104-A4
-----------------	----------------------

